

INSTRUCTION MANUAL

TALES OF THE ABYSS™



WARNING: READ BEFORE USING YOUR PLAYSTATION®2 COMPUTER ENTERTAINMENT SYSTEM.

A very small percentage of individuals may experience epileptic seizures when exposed to certain light patterns or flashing lights. Exposure to certain patterns or backgrounds on a television screen or while playing video games, including games played on the PlayStation 2 console, may induce an epileptic seizure in these individuals. Certain conditions may induce previously undetected epileptic symptoms even in persons who have no history of prior seizures or epilepsy. If you, or anyone in your family, has an epileptic condition, consult your physician prior to playing. If you experience any of the following symptoms while playing a video game – dizziness, altered vision, eye or muscle twitches, loss of awareness, disorientation, any involuntary movement, or convulsions – IMMEDIATELY discontinue use and consult your physician before resuming play.

WARNING TO OWNERS OF PROJECTION TELEVISIONS:

Do not connect your PlayStation 2 console to a projection TV without first consulting the user manual for your projection TV, unless it is of the LCD type. Otherwise, it may permanently damage your TV screen.

USE OF UNAUTHORIZED PRODUCT:

The use of software or peripherals not authorized by Sony Computer Entertainment America may damage your console and/or invalidate your warranty. Only official or licensed peripherals should be used in the controller ports or memory card slots.

HANDLING YOUR PLAYSTATION 2 FORMAT DISC:

- This disc is intended for use only with PlayStation 2 consoles with the NTSC U/C designation.
- Do not bend it, crush it or submerge it in liquids.
- Do not leave it in direct sunlight or near a radiator or other source of heat.
- Be sure to take an occasional rest break during extended play.
- Keep this compact disc clean. Always hold the disc by the edges and keep it in its protective case when not in use. Clean the disc with a lint-free, soft, dry cloth, wiping in straight lines from center to outer edge. Never use solvents or abrasive cleaners.



TALES OF THE ABYSS™

CONTENTS

Getting Started.....	2	Battle Menu	25
Starting Up	3	Cooking.....	29
Game Controls	4	Status.....	31
The Story	6	Library.....	33
The Characters	7	System	34
Starting the Game	10	Battle Screen	35
Game Screens	11	Screen and Rules	35
Map Screens	12	Battle Menu	37
Field Map.....	12	Fonons and Conditions	39
Normal Map.....	14	Battle Actions	41
Menu Screen.....	17	Multiplayer Battles	47
Artes	19	Credits	48
Equipment.....	23	Warranty	49
Items.....	24		

©KOSUKE FUJISHIMA

Tales of the Abyss™&©2005 NAMCO BANDAI Games Inc.

GETTING STARTED

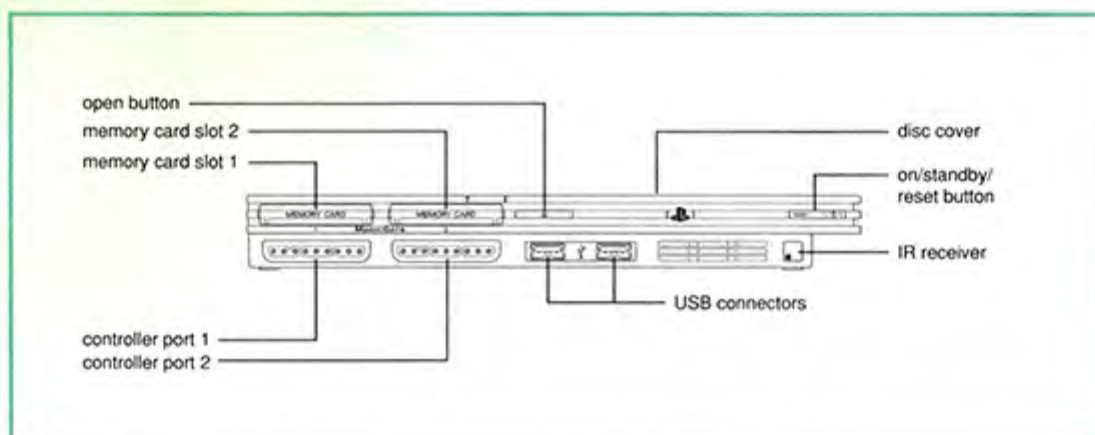

Set up your PlayStation®2 computer entertainment system according to the instructions supplied with your system. Check that the system is turned on (the on/standby indicator is green). Press the OPEN button to open the disc cover. Place the **TALES OF THE ABYSS™** disc with the label side facing up in the disc holder, and then close the disc cover. Attach game controllers and other peripherals as appropriate. Follow the on-screen instructions and refer to this manual for information on using the software.

MEMORY CARD (8MB)(FOR PLAYSTATION®2)

To save game settings and progress, insert a memory card (8MB)(for PlayStation®2) into MEMORY CARD slot 1 of your PlayStation®2 system. You can load saved game data from the same memory card or any memory card (8MB)(for PlayStation®2) containing previously saved games.

STARTING UP

DUALSHOCK®2 ANALOG CONTROLLER CONFIGURATIONS

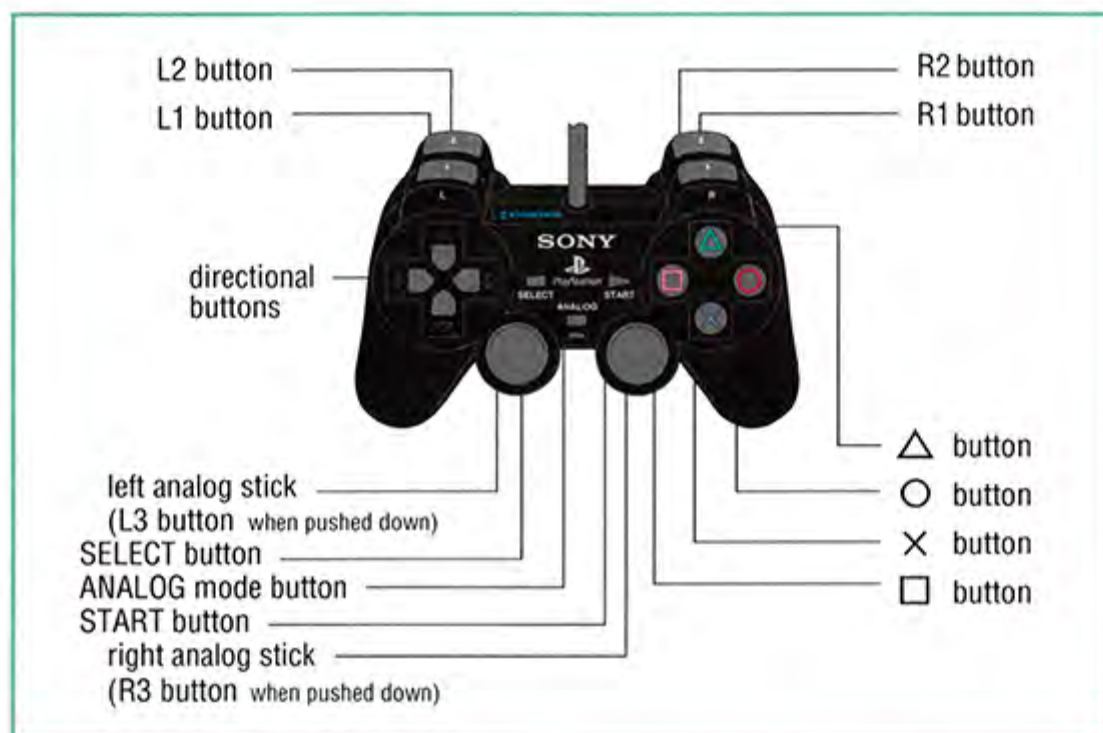

Insert the controller into controller port 1 when playing solo. This game can also be played by up to four players by using a multitap (for PlayStation®2).

** This game can only be played with a DUALSHOCK® analog controller or a DUALSHOCK®2 analog controller. Use of a DUALSHOCK® analog controller is the same as a DUALSHOCK®2 analog controller.*

** The ANALOG mode button is always ON (LED Display: Red), and cannot be turned OFF (LED Display: not lit). You can turn the vibration function ON or OFF using the Config Menu.*

GAME CONTROLS

This section explains basic game operations by screen. For details pertaining to game operations, please refer to the explanations given for each page and the key functions table.

BASIC OPERATIONS ON THE MAIN MENU

directional buttons / left analog stick	Select items
L2 button / R2 button / right analog stick	Page up / Page down
X button	Confirm selection
○ button	Cancel, Return to previous screen
L1 button / R1 button	Change character or item category
START button	Toggle window explanation

** Operations other than these will vary by menu*

OPERATIONS ON THE MAP SCREENS

FIELD MAP OPERATIONS

directional buttons / left analog stick	Move (walk while pressing ○ button)
X button	Enter town/dungeon, Search
△ button	Open Menu Screen
L1 button / R1 button / right analog stick	Rotate camera
L2 button	Enter town/dungeon, Search
R3 button	Open World Map
START button	Toggle minimap display
SELECT button	Start Skit

NORMAL MAP OPERATIONS

directional buttons / left analog stick	Move (walk while pressing ○ button, change Mieu action while pressing R2 button)
X button	Speak, Search
△ button	Open Menu Screen
□ button	Perform Mieu Action
L1 button / R1 button	Change character direction
L2 button	Speak, Search
R3 button	Open World Map
SELECT button	Start Skit

*** The directional buttons allow you to move by running, and the angle that the left analog stick is held at determines your speed.*

BASIC BATTLE OPERATIONS

directional buttons / left analog stick	Move character, Free Run (while pressing the L2 button), Select spell target (while casting a spell), Move selection cursor
right analog stick.....	Arte shortcut
X button	Normal attack
O button	Use artes (Along with directional buttons or the left analog stick)
△ button	Open Battle Menu
□ button	Defend
L1 button	Decline item request
R1 button	Choose target
R2 button	Trigger Over Limit
START button.....	Pause

** You will be able to use Free Run and Over Limit after your character has gained enough experience.*

** The Free Cursor can only be moved with the left analog stick.*

MAP COMMAND HELP

On map screens, help text will be displayed when you are near an object that you can interact with. On menu screens, the buttons that you can use on each screen and what they perform is displayed.



THE STORY

Fonons – essential components of all matter on planet Auldrant. Ages ago, a new type of fonon was discovered—the Seventh Fonon. Its discovery threw humanity into chaos, for if one could use the Seventh Fonon, one could learn the future. Wars over the Seventh Fonon raged across the lands, ending only when the miasma – a poison from within the planet – covered the entire world. This is when Yulia appeared.

A fonist skilled in prophecy, Yulia saw thousands of years into the future and foresaw a way to seal away the miasma. With the guidance of her prophecies, humanity sealed the miasma deep within the planet.

Over two thousand years passed.

The world is ruled by Yulia's prophecy, known as the Score. People believe in the coming “unprecedented prosperity” promised in the Score, never straying from the path set forth in the Score which will lead them to that prosperity. They look to the Score as revealed by the Order of Lorelei, the religion Yulia founded, and hold that the greatest virtue is to follow the Score faithfully.

Yulia's Score tells of a young man who is necessary in order to bring “unprecedented prosperity.” His name is Luke fon Fabre. An heir to the throne of the Kingdom of Kimlasca-Lanvaldear, he was kidnapped as a child by the kingdom's enemy, the Malkuth Empire. Since his return he has been confined to his family's manor for his own safety. He has no idea of the evil that now draws close.

THE CHARACTERS

LUKE

LUKE FON FABRE

Luke is the only son of a Duke of the Kingdom of Kimlasca-Lanvaldear. He lost all memory of his childhood due to the shock of being kidnapped. Since his return he has been a prisoner in his own palace, but his family's wealth has kept him in comfort, leaving him spoiled and naïve. His only hobby is practicing with his sword, and, though he lacks refinement, he does possess some skill.

Age: 17

Class: Swordsman

Height: 5'7"

Weight: 150 lbs



TEAR

TEAR GRANTS

Tear is a Seventh Fonist in the military wing of the Order of Lorelei, the religion overseeing the Score. She lost both parents when she was still an infant, and has been raised as a warrior ever since. She is staid and silent, giving her a cold air, but she has a secret weak spot for cute things. A certain incident leads to her joining with Luke on his adventure.

Age: 16

Class: Melodist

Height: 5'4"

Weight: 110 lbs

MIEU

Mieu is a young cheagle. Cheagles, considered holy by the Order of Lorelei, normally live in herds in the forest, but fate will bring him to join Luke and the others on their adventure. The Sorcerer's Ring that he wears around his tummy allows him to use human speech, and he can use the ring's fonic power to breathe fire.



THE CHARACTERS

JADE

JADE CURTISS

Jade is a colonel in the Malkuth Empire's military. He is both a skilled fonist and a master of the spear. He always smiles, so no one knows what he is truly thinking. He is known to be the right-hand man to the Malkuth Emperor, Peony, but he is also known among those in the military as "Jade the Necromancer."

Age: 35

Class: Fonist

Height: 6'1"

Weight: 163 lbs



ANISE

ANISE TATLIN

Always cheerful and happy, Anise is a Fon Master Guardian, charged with personally protecting Fon Master Ion, the leader of the Order of Lorelei. The stuffed doll, Tokunaga, that she keeps strapped to her back can grow to gargantuan size, and she fights while riding on its back. She hopes to marry rich, and ever since meeting Luke she has been plotting to become his future duchess.

Age: 13

Class: Puppet Master

Height: 5'0"

Weight: 93 lbs

GUY

GUY CECIL

Guy is a servant in the Fabre household. He was first taken on as a babysitter, and ever since then, Guy has been like both a brother and a parent to the palace-bound Luke. He is uncomfortable around women, so his kind words to them often lead to awkward situations.

Age: 21

Class: Swordsman

Height: 6'

Weight: 174 lbs



NATALIA

NATALIA LUZU KIMLASCA LANVALDEAR

Natalia is the princess of the Kingdom of Kimlasca-Lanvaldear. She is haughty and arrogant, but at the same time, as a member of the royal family she is concerned for her subjects and for her country. She is proficient with a bow, and difficult situations bring out the true strength of her will. Natalia is engaged to Luke, and their life-long friendship allows her to freely criticize him for his lapses in judgment.

Age: 18

Class: Archer

Height: 5'6"

Weight: 117 lbs

STARTING THE GAME

The opening movie plays after the game is started. You may skip the movie by pressing the START button, or wait until the movie ends and the title screen is displayed.

THE TITLE SCREEN

The following three menu items will be displayed. Use the directional buttons or move the left analog stick up or down to choose a menu item, and press the  button.

NEW GAME

Starts a new game from the beginning.

CONTINUE

If previously saved game data exists on a memory card (8MB) (for PlayStation®2), you can load that game and continue playing. Choose the data you wish to load and press the  button, then select “Yes” when the confirmation message is displayed.



CONFIG

This allows you to set various game settings in the same manner as “Config” in the System Menu.

GAME SCREENS

This section explains the main screens used in Tales of the Abyss and their relationships to one another. See the pages related to each screen for further details.

THE RELATIONSHIP BETWEEN THE SCREENS

You will move over map screens in towns and dungeons, and use the Menu Screen to perform various actions and change settings. The game changes to the Battle Screen when you meet enemies on the field, or when a battle begins during an event.

FIELD MAP

You can travel on the Field Map to visit various towns and dungeons.



MAP SCREENS

NORMAL MAP

This is the screen shown when you are gathering information in towns or searching through dungeons.



MAIN MENU

In this menu you can use items, confirm information, and change game settings.



BATTLE SCREEN

On this screen you control the characters during battles with enemies, and earn experience points after a victory.



MAP SCREENS (FIELD MAP)

This section explains the parts of the map screens. The Normal Map includes screens used not only in towns, but also those used in dungeons.

PARTS OF THE SCREEN

You use the Field Map to travel to the various towns and dungeons that are scattered throughout the world. Be sure to visit all of the places that you can.

[COMPASS]

The N, S, E, and W characters indicate the four points of the compass. The red arrow indicates the facing of the currently moving character.

[ENEMIES]

Touching an enemy causes a battle to begin.

[SKIT TITLE]

(see page at right)



[MINIMAP]

The minimap allows you to see your current location and the direction the camera is facing. Press the START button to toggle between these settings:

- Minimap ON
- Zoom View
- Minimap OFF

ENTERING TOWNS AND DUNGEONS

When you move close to a town or dungeon on the Field Map, its name will be displayed. Press the **X** button to enter.



USING VEHICLES

As the game progresses, Luke and his companions will obtain vehicles that allow them to travel by sea and by air. You will not encounter enemies while you are using vehicles, and you will be able to visit new places that you couldn't get to before.

THE WORLD MAP

At some point during your adventure you will obtain a World Map, and after doing so pressing the R3 button will display it (you can also display the World Map on the Normal Map). Any locations that you have visited will be displayed in World Map categories. You can toggle between lists of towns, dungeons, and other locations by pressing the **L1** and **R1** buttons, and see where those locations are by highlighting them. You can display a zoomed view of the map by pressing the **□** button, and view a list of shops by pressing the **⊗** button on a town name. You can also view the World Map by selecting “Library” from the Main Menu.



VIEWING A SKIT

Press the SELECT button when a skit title is displayed to view a conversation between each of the characters. These chats may be about anything, from simple conversations to hints about your adventure. You may also view Skits on the Normal Map.

BEWARE SURPRISE ENCOUNTERS!

If an enemy comes in contact with the player character from behind, then a surprise encounter will result. In surprise encounter battles, characters that take part in the battle are chosen at random, regardless of the established battle order. This means that characters that you have removed from the battle order due to low HP, low TP, or debilitating statuses may be forced to fight, so be careful! Note that the first character in the battle order will always fight.

MAP SCREENS (NORMAL MAP)

The Normal Map is displayed when you enter a town or a dungeon. This section explains basic operations on that screen and the various services available when you enter a town.

NORMAL MAP

You can move on the Normal Map by pressing the directional buttons or the left analog stick. You can walk by pressing the **○** button while pressing the directional buttons or the left analog stick. You can change the direction the character faces by pressing the **L1** button or **R1** button, and pressing the **△** button opens the Main Menu.



[MIEU ACTIONS]

This is displayed while the R2 button is pressed, and indicates the current Mieu Action (see page at right).

[TREASURE CHEST]

You can get the items found within a treasure chest by standing close to it and pressing the **×** button.

[ENEMIES]

Touching an enemy begins a battle.

[SKIT TITLE]

SAVE POINTS

You can save the game by pressing the **×** button while you are standing on a Save Point in a town or in a dungeon. Choose a location where you wish to save your data, and press the **×** button.

Green Save Points will also fully restore your HP and TP while you are standing on them.



SPEAK / LOOK

You can speak to people by facing them and pressing the **X** button. You can also read signs or open doors and treasure chests in the same manner. A help display will be shown at the bottom right of the screen when you can perform these actions. You can also perform the same action to open treasure chests on the Field Map.



MOVE OBJECT

You can move some objects that you find in towns and dungeons. To do so, face the object that you want to move, and use the directional buttons or the left analog stick while pressing the **X** button. Use the help display at the bottom right of the screen as a guide to let you know when you can do this. Note that you can both push and pull objects.

MIEU ACTIONS

After you have added Mieu to your party, you can press the **□** button to have him blow flames. There are many ways to make use of this, such as to burn away vegetation that is blocking your path. You will also learn new actions as your journey progresses. By making appropriate use of Mieu Actions you will be able to enter new dungeons, so try them out in a variety of places!



Use flames...
to burn away grass!

CHANGING ACTION

After you've learned new Mieu Actions, hold down the **R2** button to display the current action in the upper right. You can then use the directional buttons or the left analog stick to change the Mieu Action to something different.



MAP SCREENS (NORMAL MAP)

USING SHOPS

There are several types of shops, including weapon, armor, food, and tool shops. Food shops sell ingredients required for cooking, and tool shops sell healing items and such. Speaking to a shopkeeper causes the following menu to be displayed:

THE SHOP MENU

Buy.....	Buy an item
Sell	Sell items that you have
Equip	Equip weapons or armor
Exit	Finish buying and selling and leave the shop

INNS

By paying Gald (money) at an Inn, all characters' HP and TP will be restored to their maximum values, and all Status Effects, such as Poison and KO, are restored to normal.

THE TOWN LINK SYSTEM

Many things other than the events occurring in the main story will affect the towns found throughout the game, and as a result the towns will change. The following are some examples of changes that you may see:

CHANGES IN ITEM PRICES

The prices that shops charge for items will change, depending on the status of the town and on your party's actions. For example, if the party has helped someone in the past, that person may sell items to them for a lower price. When war is in the air, causing tensions to rise, prices may rise as well.

CHANGES IN ITEMS SOLD

Just as with prices, the types of items sold may change. This is especially true when war threatens, as shortages will occur, making some items disappear from stores.

OTHER CHANGES

As a result of other events, you may be able to enter previously inaccessible areas, or meet new people. The group's actions may also result in unexpected consequences.

MENU SCREEN

Pressing the **△** button while on a map screen opens the Main Menu. From the Main Menu you can enter various sub-menus.

MAIN MENU

Use the directional buttons or the left analog stick to move the cursor and highlight a menu item, press the **⊗** button to select it. Pressing the START button will change the information shown in the Character Window.

[DISPLAY CHARACTER]

The character marked with a red flag is the character that is displayed on the map screens.

[MENU LIST]

See pages 19 – 34 for an explanation of the various menus.

[PLAY INFORMATION]

The following is information related to play:

PLACE

The name of your current location.

GALD

The amount of money you currently have.

TIME

The total amount of time spent playing, and the amount of time played this session.

ENCOUNTERS

The number of encounters experienced so far.

HITS

The maximum number of hits attained during a battle.



[CHARACTER WINDOW]

From left to right, the information given is: the position of the character (see next page), current status (see below), the growth trends graph (see below), and a character portrait. Pressing the START button will toggle the display.

LV

Your current level.

HP

Your current and maximum Hit Points.

TP

Your current and maximum Technical Points.

OL

The current amount of your Over Limit gauge.

NEXT

The number of experience points required to reach the next level.

CAPACITY CORE GROWTH TREND GRAPHS

The graph shown in the character window represents the character's Capacity Core growth trend. Use this graph to keep track of how your character's development and enhancement are progressing.

MENU SCREEN

CHANGE DISPLAYED CHARACTER

Moving the cursor to a character window and pressing the \otimes button will let you change the character representing your party as you move on the map screens. This operation becomes possible after finding a specific item in the game.



CHANGE BATTLE ORDER

You can change the order of your characters at the Main Menu. Move the cursor to the character window, highlight the character whose order you wish to change, and press the \triangle button. Next, select a character to switch positions with and press the \otimes button to cause the two characters to exchange positions.

CHARACTER POSITIONS AND BATTLES

Characters' duties during battles will change according to their position. Be sure to set their positions correctly before a battle starts.

When playing alone, the player controls the character in position 1 (the topmost character), and its control mode can be set to "manual" or "semi-auto". Characters in positions 2 through 4 will also take part in battles. Characters in positions 5 and 6 are held in reserve, and do not take part in battles. Note that reserve party members still gain standard experience points, but not bonus experience points.

EXAMPLE: A FIVE-CHARACTER PARTY

In the example to the right, the player would operate Luke, who is in position 1. Guy, in position 5, would not take part in battles.



MENU SCREEN (ARTES)

On the Artes Menu you can adjust settings related to a character's spells (fonic artes) and skills (strike artes), and cast some spells. You can also set the control mode.

ARTES MENU

Choose "Artes" from the Main Menu and then choose a character. The Artes Menu will be shown. The menu will change slightly depending on the character's control mode.

[CURRENT CONTROL MODE]

[CHARACTER INFORMATION]

Press the **L1** or **R1** button to change the character displayed.

[ASSIGNED ARTES]

You can assign up to four artes that you will use in battle. Press the **L2** button or **R2** button to switch to the Shortcut window.

[HELP WINDOW]

This area displays the effect of an arte, the required TP to use the arte, and the number of times you have used the arte. For attacks that change within fields of fonons, pressing the **START** button allows you to confirm the changed attack.



[ARTE LIST]

This is a list of artes that the player has learned. The following icons denote the type of arte:

- Base Arte
- Fonic Arte
- Arcane Arte
- Fonic Arte (Healing)



[ARTE LIST]

[TURNING ARTES ON/OFF]

Artes with an X mark here will not be used in battle.

MENU SCREEN (ARTES)

CONTROL MODE

Each character's control mode can be set to Manual, Semi-Auto, or Auto. You will be able to set the control mode to Manual after you have found a specific item during your quest.

When playing alone, the player will control the character in Position 1 (the topmost position) during battles. Press the SELECT button to select the desired mode. All other characters should be set to "Auto". Be careful, as non-player-controlled characters that are set to "Manual" or "Semi-Auto" will not perform any actions during battle.

THE 3 CONTROL MODES

ManualThe player directly controls all actions.

Semi-Auto.....For the most part characters are player-controlled, but timing during battles and defense are automatically controlled.

Auto.....The character will fight automatically, using its previously set strategy.

FOR MULTI-PLAY

This game can be played with up to four players during battles. When two or more players are taking part, players may directly control the characters in positions 2 through 4. Set the control mode of the characters that will be player controlled to Manual or Semi-Auto to control that character in battle. Playing in multi-player mode will become possible when a certain item is found.

STRIKE & FONIC ARTES

Fonic artes and strike artes are used in the same manner, but there are a few differences between them:



FONIC ARTES

Fonic artes are performed through the recitation of some spell, and have a variety of effects such as attacking your enemies or healing your allies. Fonic artes can be powerful, but casting them takes some time, during which you must protect yourself. Note that healing fonic artes can be cast both during and outside of battle.

STRIKE ARTES



Strike artes are special attacks using weapons or parts of your body, and happen almost immediately, in combination with a normal attack. There are two types of strike artes: base artes and arcane artes, with slightly different combination rules.

ASSIGNING ARTES (MANUAL / SEMI-AUTO MODES)

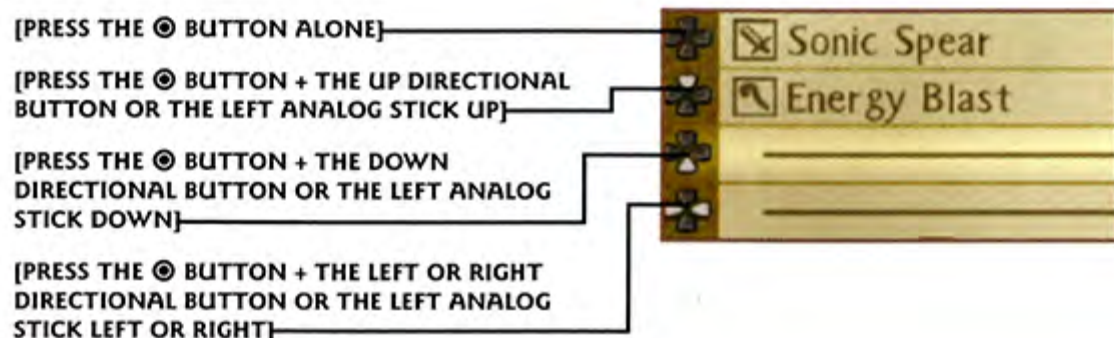
You can assign up to four artes to characters whose control mode is set to Manual or Semi-Auto. Assigned artes can be used during battles by pressing a combination of the left analog stick and the  button (or the  button alone).



ASSIGNING ARTES

Select a direction you wish to assign an arte to, and press the  button. Next, choose an arte and press the  button.



ASSIGNING SHORTCUTS (MANUAL / SEMI-AUTO MODE)

You can assign up to four shortcuts, including shortcuts to artes for characters other than the one you control. You trigger assigned artes by pressing the right analog stick during battle. Note that you cannot assign shortcuts to artes for characters that don't take part in battles (i.e., those in positions 5 and 6).



MENU SCREEN (ARTES)

ASSIGNING SHORTCUTS

Choose a shortcut you want to assign an arte to, and press the **X** button. When the cursor moves to the character information, press the directional buttons or the left analog stick left or right to choose a character, and press the **X** button. The cursor will move to a list of artes, choose an arte and press the **X** button to complete the shortcut assignment.



USING HEALING ARTES (MANUAL / SEMI-AUTO / AUTO)

Outside of battle, you can use spells that heal HP and TP or cure Status Effects. Use the directional buttons or the left analog stick to choose the spell you wish to use and press the **X** button. Next, choose the character you wish to use the spell on, and press the **△** button or the **X** button to use TP to cast the spell.



TURNING OFF ARTES (AUTO)

By choosing an arte and pressing the **□** button, you can toggle the use of that arte. Artes with an X next to them will not be used in battle.

LEARNING NEW ARTES

You can learn new artes when you reach certain experience levels. There are also artes that require you to have used certain artes a specific number of times before learning it. There are also rumors of artes hidden throughout the world.

MENU SCREEN (EQUIPMENT)

Each character is able to equip weapons, armor, and other equipment in four locations: weapon, body, hand, and other.

EQUIP MENU

Choosing Equip from the Main Menu and selecting a character takes you to the Equip Menu. Here you can press the **L1** button or the **R1** button to change the character. You can also move the cursor to the character information and press the directional buttons or the left analog stick left or right to perform the same function.

[CHARACTER INFORMATION / AUTO-EQUIP]

Moving the cursor here and pressing the **△** button will automatically equip the items that are best suited to this character.

[CURRENTLY EQUIPPED ITEMS]

[HELP WINDOW]

This area shows information about the currently selected item. Pressing the **START** button will display the statistics for the highlighted item.



[EQUIPMENT LIST]

This is a list of the items that the character can equip.

EQUIPPING WEAPONS AND ARMOR

Select the equipment slot that you wish to change and press the **×** button. Choose the item you wish to equip, and press the **×** button.

[PARAMETER CHANGES DUE TO EQUIPMENT]

Character parameters that increase when an item is equipped are shown in green, and those that decrease are shown in red.

[SORTING ITEMS]

While viewing the equipment list, you can change the item sort order by pressing the **△** button.



REMOVING EQUIPMENT

You can remove non-weapon equipment by pressing the **□** button.

MENU SCREEN (ITEMS)

The Item Menu allows you to view information about the various items that you have obtained during the game. This menu also allows you to use items such as gels and herbs.

ITEMS MENU

Items are divided into six categories. Press the **L1** button or the **R1** button to cycle through the categories. You can discard any non-Valuables by highlighting the item and pressing the **□** button.



USING ITEMS

To use an item, first select the item you wish to use and press the **⊗** button. Next, select the character you wish to use the item on, and press the **⊗** button. If you choose a weapon, armor, or accessory, then the character will equip that item.



MENU SCREEN (BATTLE MENU)

The Battle Menu lets you adjust various settings related to battles. The Capacity Core (C. Core) and Fon Slot Chamber (FSC) menu items are added as the game progresses.

ADDITIONAL SKILLS (AD SKILLS)

AD Skills are skills that allow you to add new abilities in battle like a quick Backstep or the ability to unleash additional basic attacks. You gain AD Skills by advancing in level, or by fighting with a Capacity Core equipped (see next page).

[CHARACTER INFORMATION]

Move the cursor here and press the directional buttons or move the left analog stick right or left to change characters. You can do the same thing by pressing the **L1** button or the **R1** button.

[SKILL LIST]

This is a list of all of the skills the character has obtained.

[HELP WINDOW]

This area displays information about the selected skill.



TURNING AD SKILLS ON AND OFF

Select a skill and press the **□** button to display or remove a check next to the skill name. Skills without a check will not be used during battles.

MENU SCREEN (BATTLE MENU)

CAPACITY CORES

Capacity Cores are special items that you can obtain during your adventure. They allow characters to enhance abilities or acquire new AD Skills as the characters level up. By equipping a Capacity Core according to the abilities that you want to improve, you can develop your character in just the way that you want.

[CHARACTER INFORMATION]

Move the cursor here and press the directional buttons or move the left analog stick right or left to change characters. You can do the same thing by pressing the **LS** button or the **R1** button.

[LEVEL UP BONUSES AND THEIR EFFECTS]

[HELP WINDOW]

This area shows information related to the selected Capacity Core.



[EQUIPPED CAPACITY CORES]

Capacity Cores that are equipped by a character show that character's face to the right.

EQUIPPING CAPACITY CORES

Pressing the **X** button moves the cursor to the list of Capacity Cores. Select the Capacity Core you wish to equip and press the **X** button. To remove an equipped Capacity Core press the **□** button.

LEVEL-UP BONUSES

When you level up and a Capacity Core is equipped, you will also get a Level-Up Bonus to your abilities in addition to your normal parameter bonus. You will also gain AD Skills as you keep leveling up and certain ability bonuses reach certain levels.

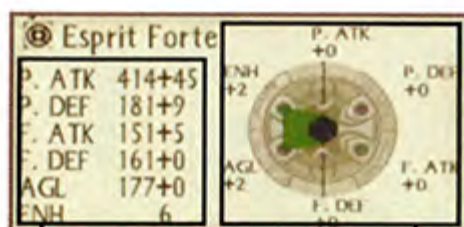

[CURRENT ABILITIES + BONUSES]

Only shows total enhancement bonus.

[LEVEL-UP BONUS VALUES]

FON SLOT CHAMBERS

Fon Slot Chambers are special items that you will obtain during your adventure. You can attach them to artes to augment the arte's effect, such as increasing the damage dealt to an enemy, decreasing the recovery time after an arte is used, etc. These special effects will occur during battles with some given probability, and when they do "FSC Effect" will be displayed. There are four types of Fon Slot Chambers: Carmine, Cobalt, Grass, and Sunlight, and each has a different effect on your artes. Be sure to try each type.

[SELECTED CHARACTER]

Press the **LT** button or the **RT** button to change characters.

[FON SLOT CHAMBER INVENTORY]

This area displays the number of available Fon Slot Chambers as well as the total number of chambers in your possession.

[ARTE DEVELOPMENT]

This is a measure of Fon Slot Chamber development, with development represented by six dots.

[HELP WINDOW]

This area displays information about the selected arte.



GROWTH GAUGE AND FSC EFFECT TRIGGERS

When you use an arte that has a Fon Slot Chamber set, its growth gauge will increase. The higher the level of the gauge, the greater the probability that it will trigger a special effect when the arte is used. When the gauge reaches the right-most dot, the special effect will always trigger. Note that special effects will only occur when the Fon Slot Chamber is equipped. Also note that if you unequip a Fon Slot Chamber when its gauge is part way between dots, its growth will shrink back to the previous dot.

SETTING A FON SLOT CHAMBER

Choose the arte that you wish to set a Fon Slot Chamber onto, and press the **X** button. Select the Fon Slot Chamber that you wish to set, and press the **X** button again to confirm. If you choose an arte that already has a Fon Slot Chamber set, then that Chamber will be replaced with the new one.

MENU SCREEN (BATTLE MENU)

STRATEGY

The Strategy Menu allows you to specify a character's actions in battle for characters whose Control Mode is set to Auto. You can also configure your battle formation (character positions during battle). You can also create battle formations and strategies other than the Default strategy type for quick strategy changes.

[CURRENT STRATEGY BEING MODIFIED]

Select this area and use the directional buttons or move the left analog stick right or left to change the current strategy.

[FORMATION DIAGRAM]

[CURRENT STRATEGY SETTINGS]

You can set what enemies each character should attack, how they should use TP, how they should move, and how they should use Over Limit.

[HELP WINDOW]

This area gives a detailed explanation of the selected option.



SETTING STRATEGY OPTIONS

Select the item you wish to change and press the **X** button. Choose a strategy option from the list shown, and press the **X** button again.

SETTING BATTLE FORMATION

First, choose the strategy type for which you wish to set a battle formation by pressing the **L1** button or the **R1** button. Next, press the **△** button to begin adjusting the battle formation. Move the character to the desired position and press the **X** button to change the character's position. Continue using the **X** button to select other characters and change their position in a similar manner. When you have finished adjusting the battle formation, press the **○** button.

[CHARACTER ICON]

Shows the position of the character.

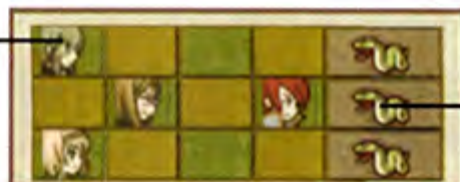

[ENEMY POSITIONS
AT THE BEGINNING
OF BATTLE]

MENU SCREEN (COOKING)

If you have the right recipes, you can use ingredients that you discover along your journey for cooking. Cooking has a variety of effects, such as healing HP and TP, etc.

COOKING

Choose Cooking at the Main Menu to display the Cooking Menu.

[COOK] — This is the character who will be cooking.

[MENU] — This is the food that will be cooked.

[REQUIRED INGREDIENTS] — These are the ingredients required to cook the selected recipe.

[EXTRA INGREDIENTS] — These ingredients can be added to the recipe to cause a variety of effects.

[RECIPE INFORMATION] —

[CHARACTER LIST] — The number of stars shows how advanced each character's cooking level is.

COOKING LEVEL

Your cooking level will increase as you repeatedly cook recipes. Characters with a high cooking level can make better versions of the same recipe. In addition, some recipes have character-specific additional ingredients that can be added if that character's cooking level is high enough.

FINDING RECIPES

When you obtain a cooking recipe, it is added to your recipe list. There are many ways to obtain recipes, such as having another character teach them to you.



MENU SCREEN (COOKING)

HOW TO COOK

Choose the character that will cook and press the **X** button. Next, choose a recipe and press the **X** button to display a list of the recipes that character knows. Choose the recipe you want to make and press the **X** button.



COOKING

After you have finished setting your cooking options, press the **△** button to use the necessary ingredients to cook the selected recipe and cause any related effects. If you have any additional ingredients they will automatically be used, changing the recipe's effect. If you are not successful at making the selected recipe, its effects will be weaker than when the attempt was successful. Also, you cannot cook when the characters are full (immediately after having cooked something).

COOKING SHORTCUTS

If you have cooking shortcuts, you can cook immediately after a battle. At the Battle Results Screen, press the directional buttons to select a recipe and then press the **□** button to cook the selected recipe.

ASSIGNING A SHORTCUT

Press the **R2** button to display the Assign Shortcuts Window. Next, choose the position for the shortcut and press the **X** button to choose a chef. After doing so, follow the same procedure to select a recipe.

MENU SCREEN (STATUS)

The Status Menu allows you to check the current condition and basic parameters of each character. Here you can also change each character's title.

STATUS

You can display the Status Menu by choosing Status from the Main Menu and then choosing the character whose data you wish to view. You can press the **L1** button or the **R1** button to change characters. Press the **L2** button or the **R2** button to switch between screen 1 and screen 2.

[CURRENT TITLE]
See next page for details concerning titles.

[PARAMETERS]



[EQUIPPED ITEMS]

WeaponSwords, staves, etc.
BodyArmor, robes, etc.
HandGloves, bracers, etc.
OtherOther equipped items
C. CoreCurrently equipped Capacity Core

[ELEMENTAL ATTRIBUTES]
Some equipped items may give elemental attributes.



[LUCK]

This is the character's current Luck. It changes each time the character stays at an inn, and affects several things such as battles, items obtained, etc.

MENU SCREEN (STATUS)

BASIC PARAMETERS

Each character's maximum HP and TP, as well as ability levels, increase each time they level up. Equipment, Capacity Cores, and AD Skills also modify these parameters.

BASIC PARAMETERS

- LV This is your current level.
- HP Current and maximum Hit Points (HP). When a character reaches 0 HP he is unconscious and cannot take part in battles.
- TP Technical Points (TP) are used to cast spells or use skills. This shows your current and maximum TP.
- OL This is your current Over Limit gauge.
- EXP This shows your Experience Points. When this reaches certain levels your character levels up, causing your basic parameters to increase. You may also learn new spells or skills when you level up.
- NEXT This shows the number of experience points you need until you level up again.
- Parameters These are values that are mostly related to fighting skills. The values shown here are modified by equipment, Capacity Cores, and other effects.

PARAMETER SCORES

- Physical Attack Your attack power when you attack an enemy with a weapon or a strike arte.
- Physical Defense Your defense power when attacked by a weapon or a strike arte.
- Fonic Attack Your attack power when you attack an enemy with a fonic arte.
- Fonic Defense Your defense power when attacked by a fonic arte.
- Agility A high agility rating increases your movement speed and your chance to perform a critical hit.
- Enhancement This score will only increase with a Capacity Core level-up bonus. When this score reaches certain levels, you can gain AD Skills as this score reaches certain levels.

TITLES

You gain titles after fulfilling certain requirements in game events. Moving the cursor to the available title and pressing the **⊗** button displays a list of available titles. Choose the one you like and press the **⊗** button again. Depending on the title used, the character may be able to use special abilities, or his appearance may change.

MENU SCREEN (LIBRARY)

On this screen you can view stories, maps, and other such items that you have obtained. Select “Library”, and then choose from among the menu items described below.

SYNOPSIS

You can read a summary of the story so far by selecting “Synopsis”. To do so, select the synopsis you wish to read and press the **X** button. You can use the directional buttons or move the left analog stick up or down to flip pages.



WORLD MAP

If you have obtained the World Map, you can view a map of the world.



COLLECTOR'S BOOK

If you have obtained the Collector's Book you can see a list of all of the items you have obtained so far.

CHARACTER BOOK

Somewhere in this world is the Character Book. If you go there and read the Character Book, you can see who lives in the towns that you have visited, as well as see the characters that you have met during game events.

MENU SCREEN (SYSTEM)

This screen allows you to save and load games, and the Config section allows you to change game settings. You can also use this area to see game-related records.

SAVE \ LOAD \ CONFIG

Save: You can save game data by choosing “Save” while in the field. Doing so displays a list of save files. Choose the file where you wish to save your game and press the **X** button.

Load: This option loads saved data. Operation is the same as “Continue” on the Title Screen.

Config: This area allows you to change game-related settings. Press the **O** button after you’ve finished to return to the Main Menu.

CONFIGURABLE SETTINGS

Message SpeedSets the speed at which messages are displayed on a scale from 1 to 10.

Battle Difficulty.....Sets the battle difficulty to “Normal” or “Hard”. Once you’ve cleared the game, new battle difficulties become available.

Vibration Function ...Turns the vibration function on or off.

Button Configuration...Allows you to change button functions during battles.

SoundAllows you to change the volume for BGM, sound effects, characters voices and also choose between “Stereo” and “Mono”.

Enemy Check.....Turning this on will cause the camera to temporarily swing to the direction of enemies when a battle starts.

Dynamic CameraTurning this on will cause the camera to dynamically change position for characters set to “Auto” mode.

Battle VoicesTurns voices during battles on or off.

Place NamesIf this is turned on, approaching an inn, weapons shop, or other place will cause the facility’s name to be displayed.

Event VoicesTurns voices on or off during events.

Skit TitlesDetermines whether titles should be displayed for Skits.

Adjust ScreenAllows you to adjust the position of the screen.

RECORDS

This allows you to see various data and records related to game-play.

BATTLE SCREEN (SCREEN AND RULES)

When a battle event occurs due to touching an enemy icon on the Map Screen, the Battle Screen is displayed. This section explains the parts of the screen and its various rules.

BATTLE SCREEN

Battles can be paused by pressing the START button. You can also press the  button during battles to display the Battle Menu, allowing a variety of actions.

[HITS / DAMAGE]

This shows the number of repeated hits that you've made, and the damage dealt.

[BATTLE MESSAGES]

[ESCAPE GAUGE]

[TARGET ICON]

This target is displayed above the head of the current target for attacks.

[ALLY STATUS]

The upper status bar and number shows the character's current HP, and the middle upper status bar and number shows the character's current TP. Both numbers will change color depending on the value of HP and TP. The bottom status bar shows the character's Over Limit gauge.



THE FLEX-RANGE LINEAR MOTION BATTLE SYSTEM (FR-LMBS)

During battles characters and their enemies will be mixed together, but the operated character will follow an invisible line drawn between him and his target. The AD Skill "Free Run" will allow the character to move freely about the battlefield. The skill "Free Target" allows some magic to have its target set to any point on the field. This is called the Flex-Range Linear Motion Battle System.



BATTLE SCREEN (SCREEN AND RULES)

BATTLE RULES

When playing solo, battles occur with the player controlling the character in Position 1, and all other characters fight automatically according to the strategies set previously. You are victorious when all enemies are defeated. When you win a battle, the Battle Results Screen appears, and you are rewarded with Gald (money) and experience points, and you will recover some TP. You will sometimes obtain items.

GAME OVER

If all characters taking part in a battle can no longer fight because their HPs were reduced to zero, or they may have acquired a physical ailment called "Petrify" (see page 40), and they are defeated and the game is over. You will have to load saved data from the Load Screen or return to the Title Screen.

THE BATTLE RESULTS SCREEN

The Battle Results Screen is displayed when you win a battle. Here you are rewarded with items and titles, and level ups are announced. Press the **X** button to dismiss the screen. Pressing **△** at this screen allows you to view details of the battle for each individual character.

DISPLAYS ON THE BATTLE RESULTS SCREEN

EXPExperience gained.

BONUS.....Added experience point bonuses awarded for combination hits.

MAX HIT.....The maximum number of chained hits obtained in the battle.

GALD.....The amount of money received.

TIME.....The time required for the battle.

GRADE.....Grade Points awarded for the battle. Grade Points can be used in a number of ways, such as spending them at the Grade Shop for special bonuses.

COOKING AT THE BATTLE RESULTS SCREEN

By pressing the directional buttons up, down, left, or right, you can cook with whatever recipes you have assigned as shortcuts. Press the **■** button at this screen to cook. Be sure to have the desired recipe and cook registered beforehand.

BATTLE SCREEN (BATTLE MENU)

Pressing the **△** button displays the Battle Menu. This menu allows you to instruct allies to use items and artes or to change their equipped items.

BATTLE MENU

Opening the Battle Menu pauses the battle, and the screen changes to one like below. You can use items, spells, or skills, or tell the party to run away. After doing so, the battle resumes.

[CURRENT STRATEGY]
(see next page)

[CURRENT CONTROL MODE]
This is displayed when you change the controlled character's control mode (see next page).

[BATTLE MENU]
This menu is made up of five menu items.

[ENEMY NAMES AND NUMBERS]



BATTLE BASIC MENU OPERATIONS

directional buttons,

left analog stick.....Select a menu item

⊗ buttonConfirm selection

⊙ buttonCancel

L1 buttonChange tactics (effective only for this battle)

START buttonChange character order (effective only for this battle)

SELECT buttonSwitch control mode (in some cases effective only for this battle)

ARTES

Choosing this item allows you to assign artes and set which artes the characters are allowed to use. You can also direct characters whose mode is set to “auto” to use a particular arte. Choose the arte you wish the character to use, if required select the location you want the spell to take effect, and then press the **⊗** button.

STRAT

This allows you to set tactics and formations.

EQUIP

This allows you to change the selected character's equipped items.

BATTLE SCREEN (BATTLE MENU)

ITEMS

This allows you to use items in the “Tool” category. Choose the character that will use the item, and choose the item to be used at the Item Screen. Next choose the target for the item. After you have decided which item to use, an Item Gauge appears on the screen, and the item will not actually be used until the gauge is empty. Note that gels and medicines can only be used on the character using the item (there are some exceptions to this, such as Life Bottles, etc.). The AD Skill “Throw Item” will allow characters to use items on other characters.



ESCAPE

You can choose to Escape from battles using this command. When you choose Escape, an Escape gauge appears at the upper left of the screen, and running away will be successful when this gauge fills up. Choosing Escape again while the Escape gauge is displayed will cancel the escape attempt.



[ESCAPE GAUGE]

CHANGING THE CHARACTER ORDER AND CONTROL MODE

Pressing the START button while the Battle Menu is displayed will rotate the character order, changing the controlled character (there are no changes made to which characters take part in the battle). Changing the character order becomes possible after finding a certain item during your adventure. Pressing the SELECT button changes the currently controlled character's control mode. Note that control mode changes will remain in effect after the battle ends if that was the only change that was made to the settings.

CHANGING THE STRATEGY TYPE

Pressing the **L1** button while the Battle Menu is displayed will change the current strategy. You will need to have set the contents of the strategy before the battle begins.

BATTLE SCREEN (FONONS AND CONDITIONS)

This section explains character conditions and the relationships between the six fonons, which play an important role in battles in Tales of the Abyss.

FONON ELEMENTAL ASSOCIATIONS

Some artes and equipment have elemental associations called “fonons”, such as earth and water. Attacks that have associated fonons will do far more damage to a character that has a weakness for the associated element. Some equipment and some monsters also have resistances to specific fonons, so be careful in your selection of which artes and items to use. You can view fonons associated with characters at the Status Screen, and you can see enemy elemental weaknesses and associations by using the “Magic Lens” item.



WIND
(GREEN)



FIRE
(RED)



LIGHT
(GOLD)



EARTH
(YELLOW)



WATER
(BLUE)



DARKNESS
(PURPLE)

FIELDS OF FONONS

Using an attack that has a fonon association will create a “field of fonons” (FOF) at the location of the attack for some specific time. Fields of fonons are uncolored at first, but when the same elemental attack is used repeatedly the fonons will build up, causing the field to take on the color of the associated element. There are also spells that will create fields of fonons of a particular element. Using certain artes while in a colored field of fonons can transform them into special elemental skills. You should make good use of fields of fonons, such as having one character create one and another character use it to launch a special attack.



UNCOLORED FIELD OF FONONS



WHEN IT OBTAINS AN ELEMENTAL ASSOCIATION...

BATTLE SCREEN (FONONS AND CONDITIONS)

AN EXAMPLE OF A SPECIAL ELEMENTAL SKILL

For example, Jade can use Icicle Rain, which is created by Splash used within an earth elemental field of fonons. Anise can use Fire Dragon Blast, which is created by Shadow Raid used within a fire elemental field of fonons. Be sure to look for other combinations.



FROM AN ELEMENTAL
FIELD OF FONONS...



USE THE BASE ARTE
FANG BLADE...



TO GET THE ELEMENTAL
ATTACK LIGHTNING
TIGER BLADE!

STATUS EFFECTS

Characters can receive Status Effects as a result of special attacks or the effects of spells or skills. Most Effects are only temporary, ending when the battle is finished, but some Effects such as Poison, Petrify, Sealed Artes, and KO can only be corrected with items or by staying at an inn.

PHYSICAL AILMENTS

- PoisonHP are lost as time passes
- Paralysis.....Various actions are limited
- PetrifyNo actions are possible
- Weak.....Maximum HP are halved
- Sick.....HP will not be recovered by healing spells or items
- Sealed Artes.....Cannot use artes
- KOHP are at zero, and no actions are possible

Note: The game is over if all party members become petrified or KO'd.

MAGICAL AILMENTS

- Physical Attack increasedAttack power is increased
- Physical Defense increasedDefense power is increased
- Fonic Defense increasedDefense power against enemy spells is increased
- Casting time improved.....Cast spells more quickly
- Auto-recoverAutomatically recover from KO
- HeavyMovement speed is halved

BATTLE ACTIONS

This section explains how to operate your character when the control mode is set to “Manual” or “Semi-Auto”. Note that the same action can differ for different characters.

- * The symbols **↑**, **↓**, **←**, and **→** in the explanations below are associated with either the up, down, left, and right directional buttons or the directions of the left analog stick.
- * Command descriptions in the form “**⊗** button + **→**” mean to press directional buttons or the left analog stick while holding down the **⊗** button.

MOVEMENT

The following commands are used to move your character.

RUN / WALK (**←** / **→**)

Pressing the directional buttons or the left analog stick left or right will cause the character to run in that direction. You can cause the character to walk by pressing the left analog stick slightly in the desired direction.

FREE RUN (**L2** BUTTON + DIRECTIONAL BUTTONS OR LEFT ANALOG STICK)

If you have obtained the “Free Run” AD Skill then you can hold down the **L2** button while pressing the directional buttons or the left analog stick to move the character freely to any part of the battlefield. You cannot attack or cast any spells while doing this.

JUMP **↑** (IN SEMI-AUTO MODE, **⊙** BUTTON + **↑**)

When the control mode is set to Manual, you can jump by pressing the up directional button or pressing the left analog stick up. Under Semi-Auto mode you can jump by pressing the **⊙** button while pressing the up directional button or pressing the left analog stick up.

BATTLE ACTIONS

GUARD

□ BUTTON

This protects your body, lessening damage from physical attacks. Be careful, as Guard Breaks can occur if you guard too often.

OTHER GUARD ACTIONS

Characters that obtain certain AD Skills can learn how to perform a variety of guard actions. The following lists the basic ones.

Backstep □ button + ← / → (the opposite direction from which you are facing)
Avoid enemy attacks by performing a Backstep.

Critical Guard □ button + → / ← (the same direction as that which you are facing)
Greatly reduces the damage from enemy physical attacks.

Magic Guard □ button + ↓
Reduces damage from enemy magical attacks.

Recover □ button (while being blown back)
When you are blown back from taking damage, land gracefully and avoid being knocked down.

CHANGING TARGETS

R1 BUTTON

Briefly pressing the **R1** button moves the target selection to the enemy that is closest to the character. Holding the **R1** button down will pause the battle and put the game in target selection mode, allowing you to use the directional buttons or the left analog stick to choose an enemy target.



GUARD BREAKS AND DEFENSELESS

By repeatedly attacking an opponent that is guarding, you can sometimes cause a Guard Break. When this happens, the opponent's defenses are pierced, causing it to collapse and not be able to move for a period of time. Attacking an opponent's weakness, such as towards a certain attack or toward counter-attacks, can cause it to become Defenseless. Doing so may cause them to go down with a greater loss of defense than normal.

NORMAL ATTACKS

This refers to a standard attack with a weapon. When an attack hits an enemy and is not guarded, the attacking character gains a few TP. Under Semi-Auto mode, a dash attack occurs if the character is separated from the enemy. Below is an explanation of Luke's attacks.

SLASH ATTACK (X BUTTON)

This is the most basic attack, performed by swinging the sword down at the enemy in front of you.



UPPER SLASH ATTACK (← / → + X BUTTON)

This is an attack from below, swinging the sword up. Hitting the enemy just right will cause it to rise up in the air.



MIDAIR ATTACK (↑ + X BUTTON)

This is an attack by swinging the sword up while jumping up into the air. This attack is effective against enemies who are flying.



ITEM REQUESTS

Characters who are operating under Auto mode may request to use an item. Once the request is made, the character will wait a certain amount of time and then use the item. If you think that using the item isn't necessary, you can deny the request by pressing the **L1** button.

BATTLE ACTIONS

SWEEPING ATTACK (↓ + ⊗ BUTTON)

This is a wide-area attack performed by sweeping the sword horizontally.



JUMPING SLASH (⊗ BUTTON DURING A JUMP)

Pressing the ⊗ button while jumping allows you to attack enemies in midair. This attack can be chained from the Midair Attack.



A THREE-STAGE NORMAL ATTACK

By continuing to input attacks, you can chain up to three attacks. There are many possible combinations, and some attacks will vary from the standard, starting with the second stage of the attack. Below is one example.



FIRST STAGE
→ + ⊗ button



SECOND STAGE
⊗ button



THIRD STAGE
⊗ button

USING ARTES

DIRECTIONAL BUTTON OR LEFT ANALOG STICK + ○ BUTTON

The artes set in the Main Menu are used by expending TP. Press the directional buttons or the left analog stick in the appropriate direction while pressing the ○ button, or press the ○ button alone, to use the arte that is associated with the pressed direction. Casting of spells begins after this operation is complete, and the spell will trigger when the casting is complete. Be careful, as casting will be interrupted if the caster is attacked before the spell is finished.

SPELL DELAYS AND CANCELLATIONS

If the currently controlled character casts a spell, holding down the ○ button will cause the spell to be delayed until the ○ button is released. You can also cancel the casting of a spell by pressing the □ button while it is being cast.

FREE TARGETING

Some spells with areas of effect, like Splash and Healing Circle, allow you to freely set the area of effect by pressing the left analog stick while the spell is being cast to position a circular cursor (the Free Cursor). You may also use the directional buttons to select a target. You can gain an advantage in battle by accurately predicting where the enemy will be moving to and placing your spells accordingly.



[FREE CURSOR]

USING SHORTCUTS

RIGHT ANALOG STICK

Pressing the right analog stick up, down, left, or right allows you to use the shortcuts assigned to those directions. You can associate shortcuts with characters other than the one being controlled, with operations associated with other characters becoming a command to the character to use that arte.

BATTLE ACTIONS

ARTE COMBOS

Arte combos refer to a continuous chaining of normal attacks and artes without being counter-attacked by the enemy. This allows you to follow up a normal attack with a base arte and then an arcane arte or an FOF arte. Below is an example. Be sure to search for more special combos.



THREE-STAGE NORMAL
ATTACK



FANG BLADE



FANG BLADE HAVOC

TRIGGERING OVER LIMIT

R2 BUTTON

During battles, your Over Limit gauge will slowly fill as you receive damage and cause damage to your enemies. Once you have learned the AD Skill “Over Limit”, when the gauge becomes full you will be able to press the **R2** button to empty the gauge and trigger Over Limit status.

THE EFFECTS OF OVER LIMIT STATUS

Over Limit status continues for a fixed period of time and reduces the damage received from enemies. You also will not be knocked back by enemy attacks. In addition, special conditions and operations can cause you to use very powerful attacks called “mystic artes.”



STUN

Enemy attacks can sometimes stun you. While stunned, you will not be able to perform any actions. Move the left analog stick repeatedly to recover more quickly.



MULTIPLAYER BATTLES

Battles in this game can be played by up to four players. Be sure to correctly connect controllers as described below before you start playing.

PLAYING WITH TWO PLAYERS

You will need two controllers to play with two players. Connect Player 1's controller to controller port 1, and connect Player 2's controller to controller port 2. When playing with multiple players you will still need to keep a memory card (8MB) (for PlayStation®2) in MEMORY CARD slot 1.

PLAYING WITH 3-4 PLAYERS

Playing with 3-4 simultaneous players requires the use of a multitap (for PlayStation®2) and a controller for each player. Connect Player 1's controller to controller port 1, and connect the multitap (for PlayStation®2) to controller port 2. Next, connect controllers for other players in controller ports 2-A, 2-B, and 2-C, in that order. Controller port 2-D cannot be used. You cannot connect a multitap (for PlayStation®2) to controller port 1. When Playing with 3 or more players on a PlayStation®2 (SCPH-70000), use a multitap (for PlayStation®2) (SCPH-70120).

PLAYING WITH MULTIPLE PLAYERS

Players 1, 2, 3, and 4 play characters in positions 1, 2, 3, and 4 under the Top Menu Screen, respectively. Be sure to set the control mode of those characters to Manual or Semi-Auto before playing. In general, Player 1 performs all operations outside of battle.

CREDITS

DEVELOPED BY BANDAI NAMCO Games Inc.

Producer
Makoto Yoshidumi

Chief Director
Yoshito Higuchi

Localization Specialists
Shuichiro Miyoshi
Ko Kimura
Jeremy Clark
Naoki Shimokawa

Int'l Marketing Strategy Team
Rachel Lee

NAMCO TALES STUDIO LTD.

PUBLISHED BY NAMCO BANDAI Games America Inc.

DEVELOPMENT

Senior Vice President of Development
Makoto Iwai

Product Group Director
Yoshi Niki

Localization Manager
Hiroshi Tanaka

Associate Localization Producer
Peter Garza

Localization Specialist
Junko Nakamura

MARKETING & PR

Marketing Director
Yoko Nakao

Product Marketing Manager
Tara Samuels

Marketing Coordinator
Kristeen L. Kennedy

Senior PR Manager
Mika Kelly

PR Manager
Melody Pfeiffer

QUALITY ASSURANCE

Director of Publishing Support
Glen A. Cureton

QA and Customer Service Manager
Chuck McFadden

QA Supervisor
Daryle Tumacder

Senior QA Lead
Jesse Mejia

Assistant QA Lead
Jesse Bell

QA Testers
Andrew Samoranos
Bryan Maxwell
Connie Chan
Damon Bernal
David Miller
Greg Anderson
John McMahan
John VanOsten
Mia Pelayo
Mike Desenganio
Mike Stevens
Paul Huynh
Phil Farkaly
Salim Hussein
Saveth Orm
Tom McKay
Tony DiAndrea
William Chan
Wisdom Hong

Special Thanks to:

Genichi Ito
Nobuhiro Kasahara
Garry Cole
Shuji Nakata
Takahiro Sasanoi
Brian Schorr
Jae Chang
Ryan Chennault
Jennifer Tersigni
8-4, Inc.
Cup of Tea Productions, Inc.
Tom Usher Designs
Belay Development
Ignited Minds
Bandai Hong Kong
Alpha US

All fans on the Tales forums!
<http://tales.namco.com/forums>

Fonts used in-game are provided by Bitstream Inc.
All rights reserved.

LIVE HELP NOW AVAILABLE ONLINE!

Ever get stuck and just need that extra edge to beat the level?

Having problems getting your game to work properly?

**Now you can get one-on-one help from NAMCO BANDAI Games America Inc.
using your web browser!**

Simply go to livehelp.namco.com for more details.

Live Counselors available from 9am-5pm Monday-Friday Pacific Time.

NAMCO BANDAI Games America Inc.

ATTN: Customer Service

4555 Great America Parkway, Suite 201

Santa Clara, CA 95054

Before returning any defective materials to us, please contact us for a Return Merchandise Authorization (RMA) number. You can reach us at the address above, via e-mail at support@namcobandaigames.com or contact us at (408) 235-2222. Please note that any materials sent to us without an RMA number will be refused and returned. We highly recommend that you use a traceable and / or insured method of shipping the materials to us.

Namco Bandai Games America Inc. Online:

www.namcobandaigames.com

Visit our Website to get information about our new titles.

LIMITED WARRANTY

NAMCO BANDAI Games America Inc. warrants to the original purchaser that this NAMCO BANDAI Games America Inc. game pack shall be free from defects in material and workmanship for a period of ninety (90) days from the date of purchase. If a defect covered by this limited warranty occurs during this 90-day limited warranty period, NAMCO BANDAI Games America Inc. will repair or replace the defective game pack or component part, at its option, free of charge.

This limited warranty does not apply if the defects have been caused by negligence, accident, unreasonable use, modification, tampering, or any other cause not related to defective material or workmanship.

LIMITATIONS ON WARRANTY

Any applicable implied warranties of merchantability and fitness for a particular purpose, are hereby limited to ninety (90) days from the date of purchase and are subject to the conditions set forth herein. In no event shall NAMCO BANDAI Games America Inc. be liable for consequential or incidental damages resulting from the possession or use of this product. The provisions of the limited warranty are valid in the United States only. Some states do not allow limitations on how long an implied warranty lasts, or exclusion of consequential or incidental damages, so the above limitation or exclusion may not apply to you. This limited warranty provides you with specific legal rights. You may have other rights which vary from state to state.

To register product online go to
WWW.NAMCOREG.COM

THE DEATH OF ONE
AWAKENS A PATH
TO THE END.



Xenosaga
EPISODE
III

Also sprach Zarathustra

AVAILABLE NOW.



Language
Mild Suggestive Themes
Violence



PlayStation 2



www.namcobandagames.com

Xenosaga® EPISODE III Also sprach Zarathustra & ©2001-2006 NAMCO BANDAI Games Inc. "PlayStation" and the "PS" Family logo are registered trademarks of Sony Computer Entertainment Inc. The ratings icon is a registered trademark of the Entertainment Software Association. All other trademarks and trade names are the properties of their respective owners.